









# SMT Power Inductor

High Current Molded Power Inductor - PA4345.XXXNLT Series



-  **NEW** - AEC-Q200 Qualified
-  **Height:** 2.0mm Max
-  **Footprint:** 6.0mm x 5.4mm Max
-  **Current Rating:** up to 18.0A
-  **Inductance Range:** 0.1uH to 1.5uH
-  Shielded construction and compact design
-  High current, low DCR, and high efficiency
-  Minimized acoustic noise and minimized leakage flux

## Electrical Specifications @ 25°C - Operating Temperature -40°C to +125°C

Part Number	Inductance 100KHz, 1V  uH	Rated Current  A	DC Resistance		Saturation Current Max.  A
			MAX.	TYP.	
			mΩ	mΩ	
PA4345.101NLT	0.10±30%	18.0	4.0	3.6	45.0
PA4345.151NLT	0.15±30%	16.0	4.6	3.8	27.0
PA4345.221NLT	0.22±20%	15.0	5.5	4.0	25.0
PA4345.241NLT	0.24±20%	13.0	7.0	6.0	23.0
PA4345.331NLT	0.33±20%	12.0	7.3	6.3	21.3
PA4345.471NLT	0.47±20%	11.5	8.6	7.3	18.0
PA4345.681NLT	0.68±20%	10.0	12.4	11.0	12.8
PA4345.102NLT	1.0±20%	7.0	20.0	17.5	13.7
PA4345.122NLT	1.2±20%	6.2	28.0	23.0	11.0
PA4345.152NLT	1.5±20%	5.5	30.5	26.5	9.8

### Notes:

- Actual temperature of the component during system operation (ambient plus temperature rise) must be within the standard operating range.
- The saturation current is the current at which the initial inductance drops approximately 30% at the stated ambient temperature. This current is determined by placing the component in the specified ambient environment and applying a short duration pulse current (to eliminate self-heating effect) to the component.
- The rated current is the DC current required to raise the component temperature by approximately 40°C. Take note that the components' performance varies depending on the system condition. It is suggested that the component be tested at the system level, to verify the temperature rise of the component during system operation.
- The part temperature (ambient+temp rise) should not exceed 125°C under worst case operating conditions. Circuit design, PCB trace size and thickness, airflow and other cooling provisions all affect the part temperature. Part temperature should be verified in the end application.

USA 858 674 8100

Germany 49 2354 777 100

Singapore 65 6287 8998

Shanghai 86 21 62787060

China 86 755 33966678

Taiwan 886 3 4356768

# SMT Power Inductor

High Current Molded Power Inductor - PA4345.XXXNLT Series



## Mechanical

### PA4345.XXXNLT

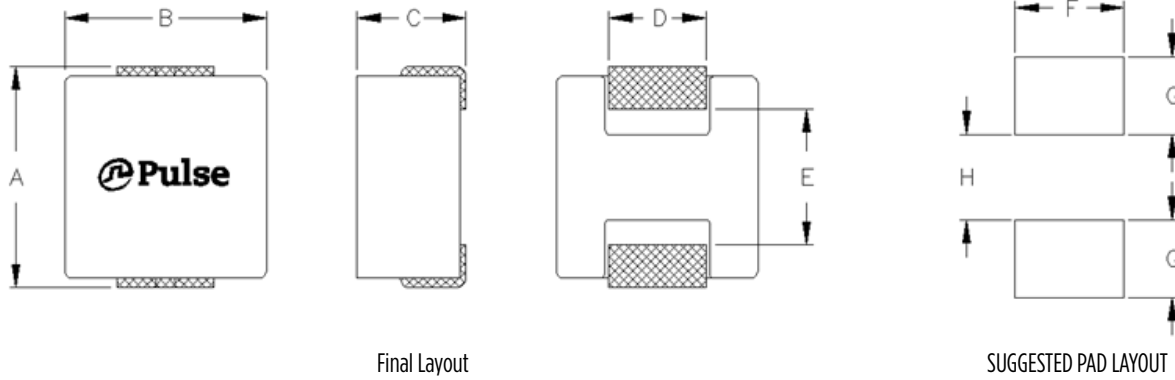

Series	A	B	C	D	E	F	G	H
PA4345.XXXNLT	6.0 Max	5.4 Max	2.0 Max	(2.5)	(3.5)	(2.8)	(2.0)	(2.2)

All Dimensions in mm.

### TAPE & REEL INFO

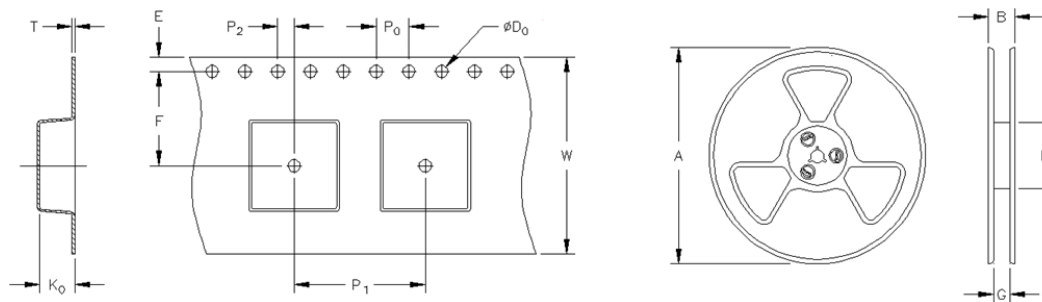

### SURFACE MOUNTING TYPE, REEL/TAPE LIST

	REEL SIZE (mm)				TAPE SIZE (mm)									QTY
	A	B	G	N	E	F	D <sub>0</sub>	P <sub>1</sub>	P <sub>0</sub>	P <sub>2</sub>	W	T	K <sub>0</sub>	PCS/REEL
PA4345.XXXNLT	Ø330	N/A	12	100	1.75	5.5	1.5	8	4	2	12	0.35	2.3	3000

## Typical Performance Curves

PA4345.101NLT

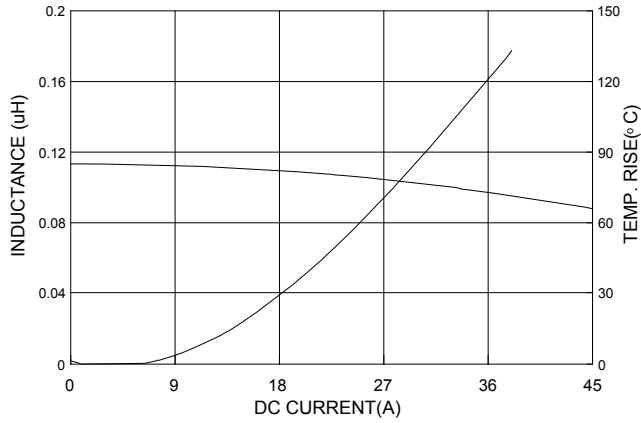

PA4345.221NLT

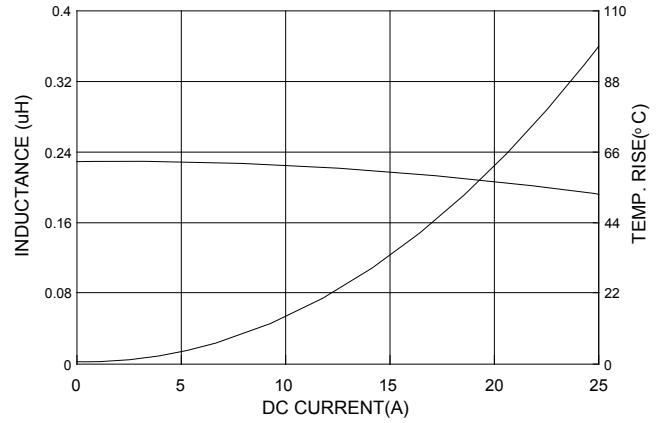

PA4345.331NLT

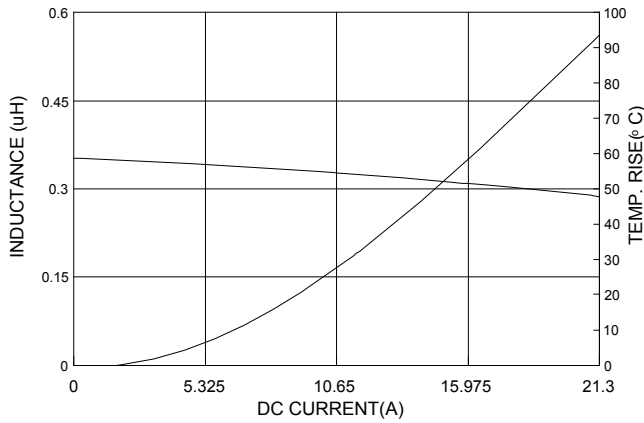

PA4345.471NLT

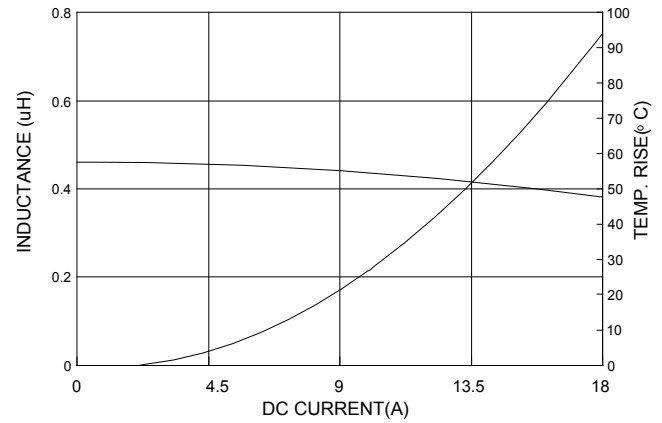

PA4345.681NLT

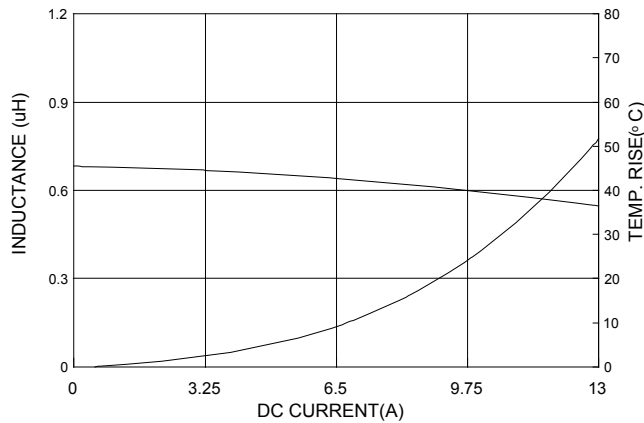

PA4345.102NLT

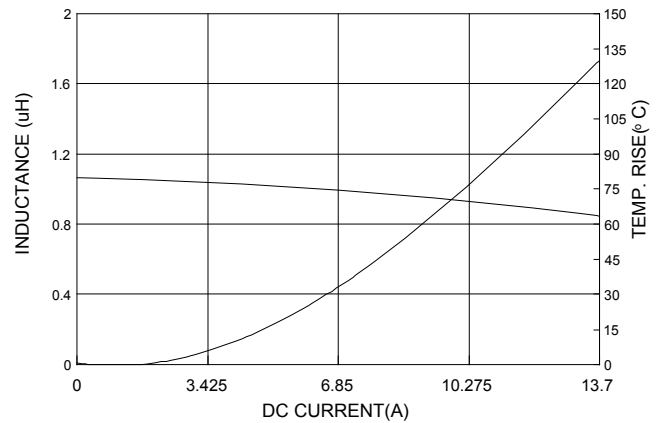

# SMT Power Inductor

High Current Molded Power Inductor - PA4345.XXXNLT Series



PA4345.122NLT

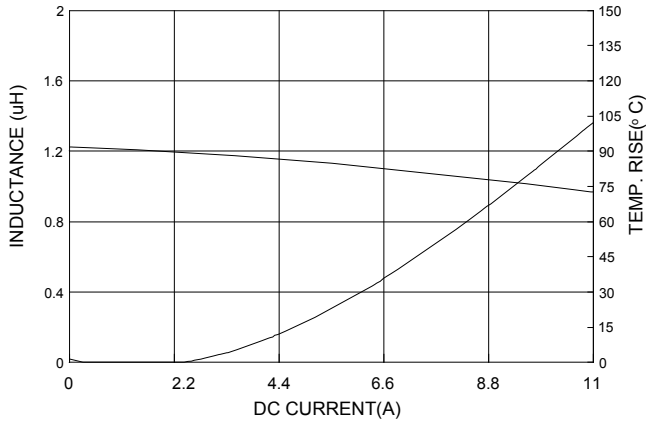

PA4345.152NLT

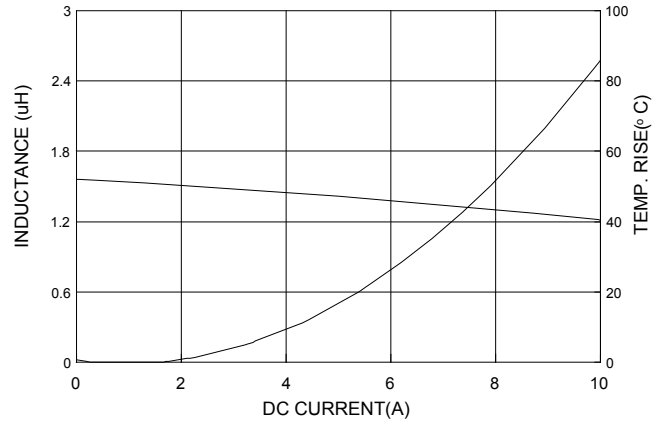

PA4345.222NLT

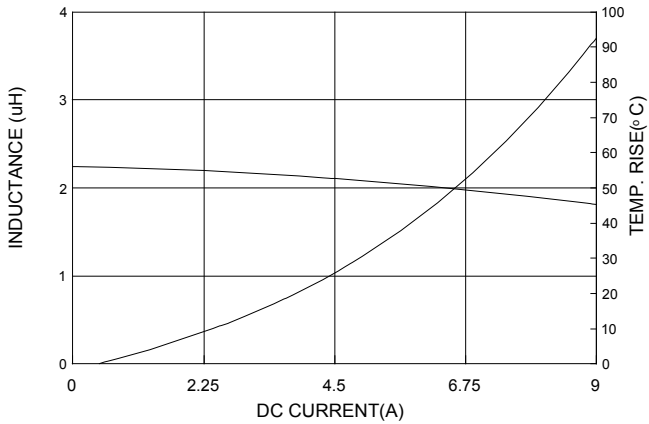

PA4345.332NLT

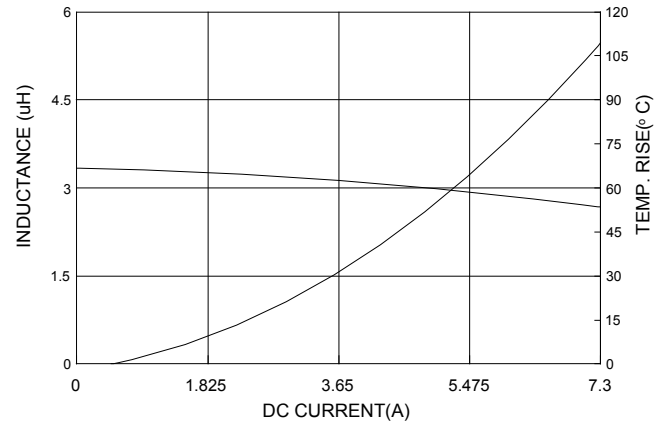

PA4345.472NLT

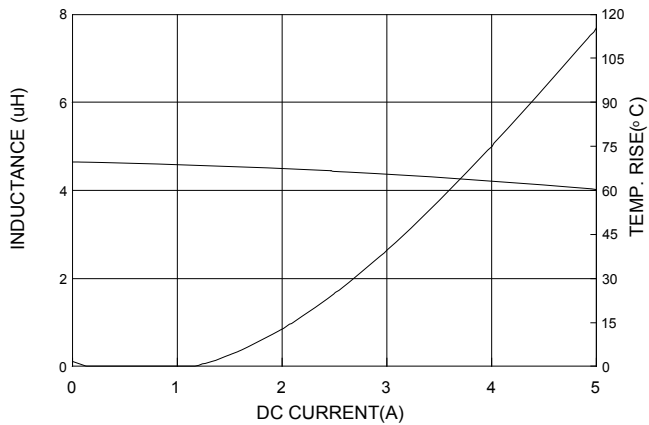

PA4345.562NLT

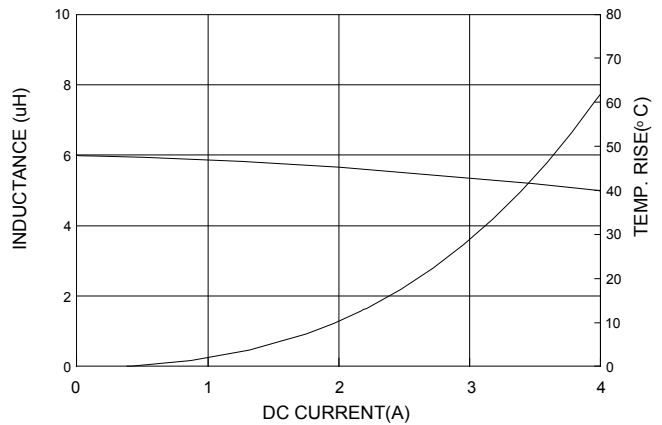

# SMT Power Inductor

High Current Molded Power Inductor - PA4345.XXXNLT Series



PA4345.682NLT

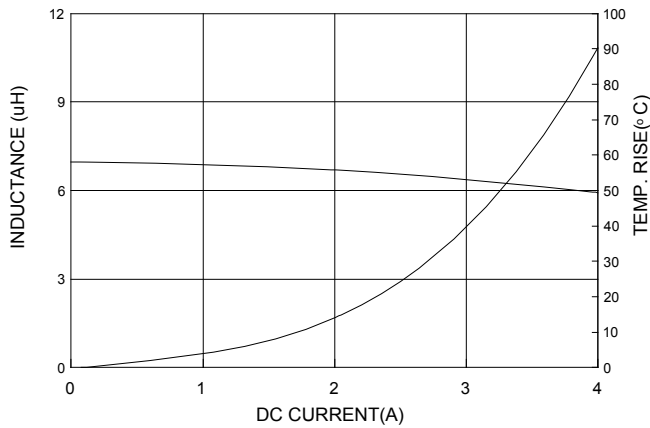

PA4345.822NLT

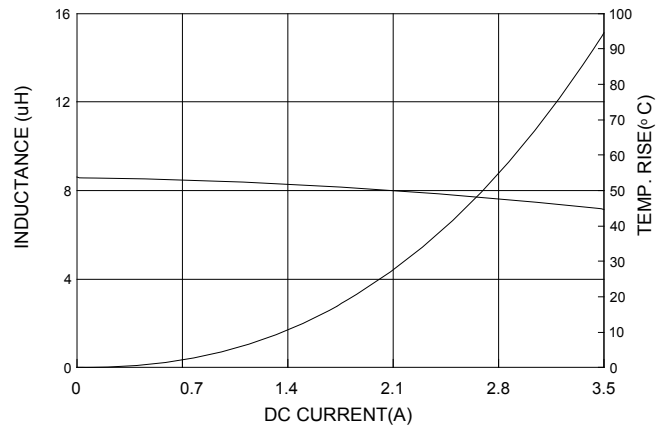

PA4345.103NLT

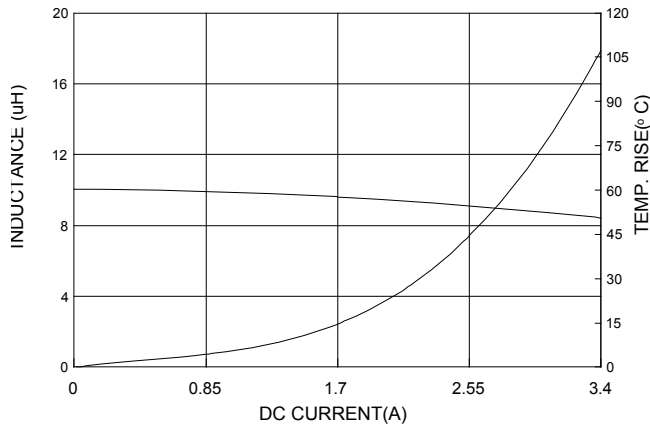

## For More Information

### Pulse Worldwide Headquarters

12220 World Trade Drive  
San Diego, CA 92128  
U.S.A.

Tel: 858 674 8100  
Fax: 858 674 8262

### Pulse Europe

Pulse Electronics GmbH  
Am Rottland 12  
58540 Meinerzhagen  
Germany

Tel: 49 2354 777 100  
Fax: 49 2354 777 168

### Pulse China Headquarters

B402, Shenzhen Academy of  
Aerospace Technology Bldg.  
10th Kejian Road  
High-Tech Zone  
Nanshan District  
Shenzhen, PR China 518057

Tel: 86 755 33966678  
Fax: 86 755 33966700

### Pulse North China

Room 2704/2705  
Super Ocean Finance Ctr.  
2067 Yan An Road West  
Shanghai 200336  
China

Tel: 86 21 62787060  
Fax: 86 2162786973

### Pulse South Asia

135 Joo Seng Road  
#03-02  
PM Industrial Bldg.  
Singapore 368363

Tel: 65 6287 8998  
Fax: 65 6287 8998

### Pulse North Asia

3F, No. 198  
Zhongyuan Road  
Zhongli City  
Taoyuan County 320  
Taiwan R. O. C.

Tel: 886 3 4356768  
Fax: 886 3 4356823 (Pulse)  
Fax: 886 3 4356820 (FRE)

Performance warranty of products offered on this data sheet is limited to the parameters specified. Data is subject to change without notice. Other brand and product names mentioned herein may be trademarks or registered trademarks of their respective owners. © Copyright, 2016. Pulse Electronics, Inc. All rights reserved.