

Date	SYM	REVISION RECORD	AUTH	DR.	CK.
05/06/16	A	Updated material note	T.B.	B.S.	

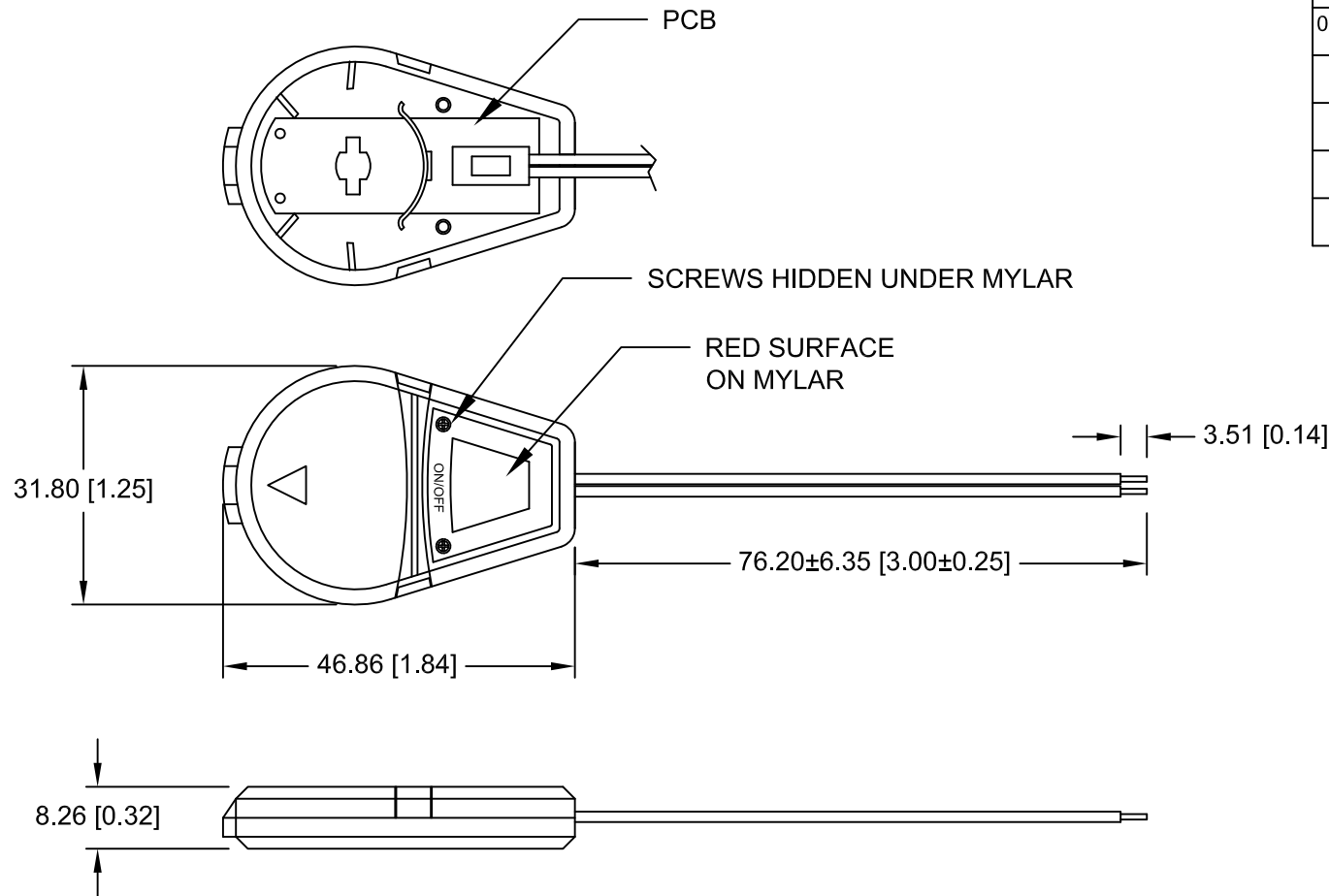

NOTES:

1. MATERIAL:

HOUSING: BLACK POLYPROPYLENE, UL FILE NO. E108370
 FLAMMABILITY RATED: UL 94-HB
 TEMPERATURE RANGE: -40°C TO +85°C
 WIRES: 24 AWG, BLACK FOR NEGATIVE,
 BLACK WITH WHITE TRACE FOR POSITIVE
 BUTTON OVERLAY: 0.010" THICK MYLAR,
 PCB: SWITCH AND POSITIVE AND NEGATIVE
 CONTACTS FOR BATTERY
 SCREWS: M1.6x6Mmm CRS/NI PLATED

2. ROHS 2 COMPLIANT

CUSTOM OPTIONS AVAILABLE

CONTACT MPD FOR SWEEP, DIMMER, PULSE EFFECTS

Tolerance (Except as noted)	 Memory Protection Devices, Inc 200 Broad Hollow Road, Farmingdale, New York 11735	Scale	Drawn By B.S.
			Approved By T.B.
decimal ±.5 (.020)	Title ENCLOSED CR2032 BATTERY HOLDER WITH ON/OFF SWITCH		
Fractional ± .8 (.030)	Date 5/06/16	Drawing Number BQ2032-3	
Angular ± 3°			